

# Vet. Surgical Resources

*Quality Products for Veterinary Surgery*

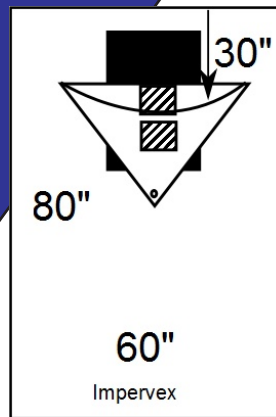
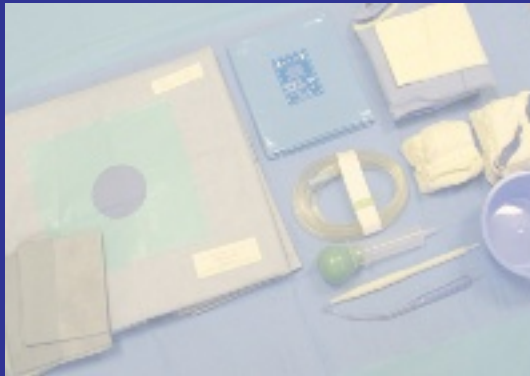

- Custom Draping
- Custom Kit Packing
- OR Supplies
- Surgical Apparel

800-354-8501  
[www.vetsurgicalresources.com](http://www.vetsurgicalresources.com)

## Our Mission Statement -

**Vet. Surgical Resources, Inc. was founded in 1992 to offer useful and innovative products for both large and small animal surgical procedures. We are dedicated to that end, offering quality products without compromise while recognizing the economics of the veterinary market.**

---

### Table of Contents

---

About Vet. Surgical Resources' Products	1
Unfenestrated Drapes	3
Small Animal Specialty Sheets	4
Small Animal Procedure Kits	7
Equine Orthopedic Drapes	9
Large Animal Specialty Sheets	11
Large Animal Orthopedic Kits	12
Large Animal Laparotomy Sheets	13
Split Sheets / Incise Drapes / Impervious Stockinette	14
Towel Drapes / Table Covers/ Sponges	15
O. R. Gowns	16
O. R. Apparel	18
Equipment Covers	19
Suction Components / Misc.	20

For pricing information, please refer to our current price list or call.

Vet. Surgical Resources, Inc.  
PO Box 368  
Darlington, MD 21034

Phone, Continental USA & Canada: 1-800-354-8501  
Fax or Phone: 1-410-457-5616  
Web Site: [www.vetsurgicalresources.com](http://www.vetsurgicalresources.com)  
Email: [wecare@vetsurgicalresources.com](mailto:wecare@vetsurgicalresources.com)

Softesse is a registered trademark of DuPont.  
Kraton is a registered trademark of Kraton Performance Polymers.  
Ioban 2 and Steri-Drape are trademarks of 3M Healthcare.  
VI-Drape and ACTI-Gard are registered trademarks of Medical Concepts Development.

---

## About Vet. Surgical Resources' Products

Vet. Surgical Resources offers an extensive line of disposable drapes for both small and large animal surgical procedures. To assist you in making the best choice for your needs, please see the general information below, regarding materials, construction, and sterilization of our products.

**Sterilization** – Sterile products offered by Vet. Surgical Resources are either ETO or gamma sterilized with careful laboratory control and traceability to ensure sterility. Drapes and kits are over-wrapped and placed in either header pouches or peel-pouches for sterilization.

**Quality control** – We process all of our products in adherence with a rigorous quality control system, ensuring that our customers may use our products with confidence.

**Drape folding** – Drapes are fan-folded and open to the short dimension first. Drapes folded to open to the long dimension first are noted in the drape descriptions and by the addition of the suffix “-1” to the product number. For example, 6011-1 denotes a 55” X 77” drape opening to the long dimension first. An “A” in the drape number indicates Impervex material with the poly side folded away from the patient.

**Non-sterile products** – Many Vet. Surgical Resources drapes may be purchased non-sterile for practices wishing to assemble their own kits. Drapes of Softesse medical fabric, SMS, and Dexter may be either ETO sterilized or autoclaved. Products made from our Impervex material must be either ETO or gamma sterilized.

**Special drapes and custom kits** – To meet your special needs, we would be happy to provide quotes on kits of drapes and other components as well as drape configurations not shown here.

**Specifications** – We continue to improve our products and reserve the right to change the specifications of our products without notice. For our most up to date product listings please view our online catalog at [www.vetsurgicalresources.com](http://www.vetsurgicalresources.com).

### **Materials** –

**Softesse® medical fabric** – This spunlaced material is widely used in both drapes and gowns in the human field. Because of its softness, Softesse medical fabric has excellent draping characteristics and will resist tearing when fenestrated for surgery. Softesse medical fabric is not impervious, but is treated to minimize moisture penetration. Autoclavable.

**Impervex medical fabric, Vet. Surgical Resources' impervious material** – Softesse medical fabric laminated with polyethylene film. Our Impervex material builds on the draping qualities of Softesse medical fabric by adding a completely impervious film. This film is an effective viral barrier, reduces linting, and aids in forming a seal at the surgical site when fenestrated at the time of surgery.

**SMS material** – This material is formed from three layers of polypropylene fibers welded together to form the completed product. It exhibits good tear resistance, low linting, and is treated for moisture resistance. Autoclavable.

**Dexter non-woven material** – This material is widely used in the human field for both main drapes and towel drapes. Caution is required when fenestrating for surgery because of its low tear resistance. This material is treated for moisture resistance. Autoclavable.

**Plastic material** – Plastics are completely impervious. Color is noted in product descriptions.

**Kraton® material** – This elastomeric material is used to make the conformable panels of the arthroscopy drapes. It has excellent stretch capability and forms a seal around the limb to control fluid during surgery.

**Adhesive** – Adhesive areas in our drapes are either 3M adhesive squares or incise panels custom made with a medical grade adhesive. The adhesives used for our incise panels are impregnated with iodine to make them antimicrobial.

### ***Reinforcement materials –***

Absorbent non-woven – This material will absorb fluids but maintains a very high wet strength. The underside of this material has a poly film coating so that collected fluids will not strike-through to the drape itself.

Polyfoam – This closed cell polyurethane foam has good strength along with a non-skid surface for instruments. Closed cell foam will not absorb moisture.

Impervious non-woven – Impervex material with the plastic film exposed. Used in our larger laparotomy sheets, it minimizes sticking of the bowel when used for equine colic surgery.

## Unfenestrated Drapes

Unfenestrated drapes are available wrapped and sterile or non-sterile. For non-sterile drapes add "NS" to the product number. These drapes may also be included in custom kits. Call for details.

### **Unfenestrated Softesse Medical Fabric Drapes**

Fan-folded. Autoclavable.

Size (in.)	Product Number
44" X 55"	6010-1*
55" X 77"	6011
55" X 77"	6011-1*
77" X 100"	6012-1*

\* Drape opens to long dimension first.

### **Unfenestrated Impervex Medical Fabric Drapes**

Fan-folded. Available sterile only.

Size (in.)	Product Number
40" X 40"	3005A <sup>§</sup>
40" X 60"	3010
40" X 60"	3010-1*
60" X 60"	3011A <sup>§</sup>
80" X 104"	3012A-1*, <sup>§</sup>
40" X 80"	3015
60" X 80"	3020A <sup>§</sup>
60" X 80"	3020A-1*, <sup>§</sup>
80" X 120"	3025
140" X 160"	3030 <sup>1</sup>
140" X 210"	3035

\*Drape opens to long dimension first.

<sup>§</sup>Drape folded poly side away from patient

### **Unfenestrated SMS Drapes**

Fan-folded.

Size (in.)	Product Number
40" X 42"	6081
44" X 55"	6082-1*
55" X 75"	6083-1*

\* Drape opens to long dimension

### **Unfenestrated Dexter Drapes**

Fan-folded.

Size (in.)	Product Number
48" X 48"	6001
55" X 77"	6002
77" X 112"	6003
77" X 112"	6003-1*
44" X 65"	6004
48" X 90"	6005-1*

\* Drape opens to long dimension first.

### **Bulk Drape Material**

Product No. 3215

Softesse medical fabric drape material. 53" x 100 yds./roll. Autoclavable.

### **Plastic Drapes**

Product No. 5162-1

43" X 74" blue poly utility drape. Sterile.

Product No. 6070

48" X 48" opaque poly drape. Sterile.

Product No. 6072

48" X 100" opaque poly drape. Sterile.

Product No. 6063

24" X 24" opaque poly drape. 5" X 5" unfenestrated adhesive square centered on drape. Sterile.

### **Unfenestrated Specialty Sheets**

Product No. 6041

80" X 130" unfenestrated drape. 80" X 46" clear plastic anesthesia window. Sterile.

## Small Animal Specialty Sheets

The drapes featured on this page are constructed using our Impervex material and clear plastic. The Impervex material provides superior barrier properties and excellent fluid control. The clear plastic anesthesia window is located at the head end of the drape to allow the surgeon or technician to monitor the patient without moving the drape. Drapes are available in both orthopedic and laparoscopic configurations as well as unfenestrated (previous page).

### Small Animal Arthroscopy Sheets

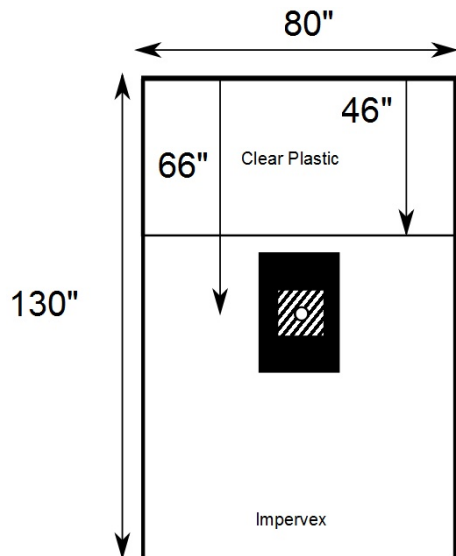

Product No. 6042 (not pictured)  
80" X 130" drape with 8" X 8" conformable panel and 2" fenestration. 20" X 30" absorbent reinforcement. 80" X 46" clear plastic anesthesia window. Sterile.

Product No. 6043 (pictured at left)  
80" X 130" drape with 8" X 8" conformable panel and 3-1/2" fenestration. 20" X 30" absorbent reinforcement. 80" X 46" clear plastic anesthesia window. Sterile.

Product No. 6044 (not pictured)  
80" X 130" drape with 8" X 8" conformable panel and 5" fenestration. 20" X 30" absorbent reinforcement. 80" X 46" clear plastic anesthesia window. Sterile.

Product No. 6046 (not pictured)  
80" X 130" drape with 9" X 9" conformable panel and 6" fenestration. 20" X 30" absorbent reinforcement. 80" X 46" clear plastic anesthesia window. Sterile.

Product No. 6048 (not pictured)  
80" X 130" drape with 16" X 16" conformable panel and 10" fenestration. 20" X 30" absorbent reinforcement. 80" X 46" clear plastic anesthesia window. Sterile.

### Small Animal Laparotomy Sheets

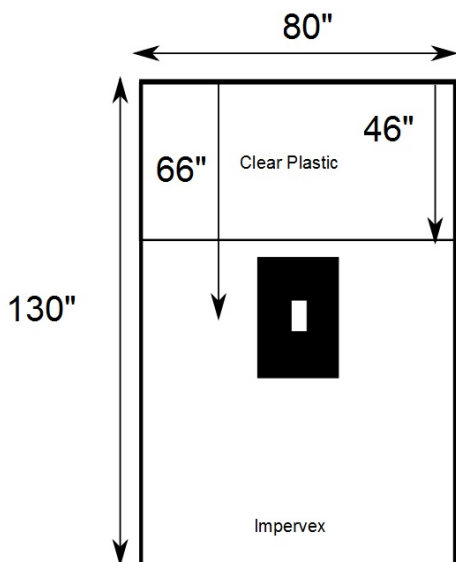

Product No. 6049 (not pictured)  
80" X 130" drape with 20" X 30" absorbent reinforcing and 4" X 6" fenestration. 80" X 46" clear plastic anesthesia window. Sterile.

Product No. 6050 (pictured at left)  
80" X 130" drape with 20" X 30" absorbent reinforcing and 4" X 8" fenestration. 80" X 46" clear plastic anesthesia window. Sterile.

Product No. 6051 (not pictured)  
80" X 130" drape with 20" X 30" absorbent reinforcing and 4" X 12" fenestration. 80" X 46" clear plastic anesthesia window. Sterile.



## Small Animal Specialty Sheets

Product No. 3021 (pictured at right)  
60" X 80" Impervex drape with 20" X 30" absorbent reinforcement and 3" X 6" fenestration.  
Sterile.

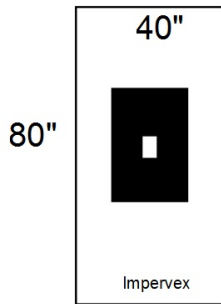
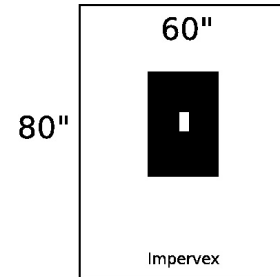

Product No. 3023-1 (not pictured)  
60" X 77" Softesse drape with 20" X 30" absorbent reinforcement and  
4" X 8" fenestration with adhesive. Sterile.

Product No. 3016 (pictured at left)  
40" X 80" Impervex drape with 20" X 30" absorbent reinforcement and  
4" X 6" fenestration. Sterile.

Product No. 3024-1 (not pictured)  
60" X 80" absorbent drape with 2" X 5" fenestration. Sterile.

### Small Animal Extremity Drapes

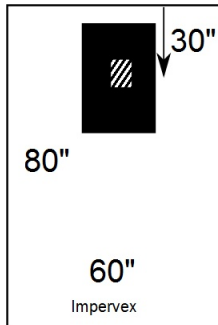

Product No. 3018  
60" X 80" fenestrated Impervex drape. 20" X 30" absorbent reinforcement. 6" X 8" conformable  
panel 30" from drape top. Sterile.

Product No. 3019-1 (not pictured)  
77" X 90" fenestrated Softesse drape. 20" X 30" absorbent reinforcement. 6" X 8" conformable  
panel 30" from drape top. Sterile.

### Small Animal Leg Drapes

Product No. 2426  
11" (28 cm) at top. 34" (86 cm) long. 2" (5 cm) cuff. Impervex. Sterile.

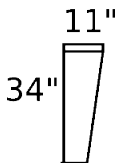

Product No. 2427 (not pictured)  
9" (23 cm) at top. 22" (56 cm) long. 2" (5 cm) cuff. Impervex. Sterile.

Product No. 2428 (not pictured)  
6" (15 cm) at top. 15" (38 cm) long. 2" (5 cm) cuff. Impervex. Sterile.

### Avian Drapes

Product No. 3101 (not pictured)  
40" X 45" clear poly drape. 5" X 5" unfenestrated adhesive square centered on drape. Sterile.

### Avian Drapes (continued)

Product No. 6059 (not pictured)  
24" X 24" opaque poly drape. 5" X 5" adhesive square with 1.5" X 2" oval fenestration centered on drape. These drapes  
are great for myelograms. Sterile.

## Small Animal Arthroscopy Drape with Pouch

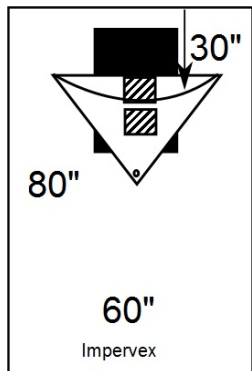

Product No. 6055 (pictured at right)  
87" X 124" SMS drape. 30" X 38" polyfoam reinforcement. 2" X 3" oval fenestration in rear conformable panel centered on mid-line. 2" round fenestration in front conformable panel in pouch. Sterile.

Product No. 6086 (pictured at left)  
60" X 80" Impervex drape with integrated fluid collection pouch. Conformable panels in both drape and pouch face. Sterile.

Product No. 6019 (pictured at right)  
20" X 18" arthroscopy fluid collection pouch. Attaches to drape with double sided tape and is held open by malleable strip. Sterile.

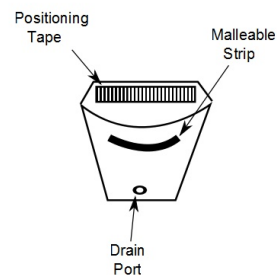
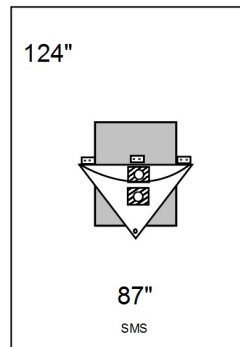

For unfenestrated drapes, please refer to page 3.

## Small Animal Eye Drapes

Product No. 6053  
40" X 60" fenestrated Softesse drape. 2-5/8" round fenestration 11" from top of drape. 1.5" X 2" oval fenestration 11" from top of drape. Each fenestration centered in a 5" X 5" adhesive square. Sterile.

Product No. 6056 (not pictured)  
Equine eye drape. 44" X 60" Dexter drape with 5" X 5" adhesive center panel and 2" round opening 24" from top of drape. Sterile.

Product No. 6057 (not pictured)  
40" X 60" fenestrated Softesse drape. 2" round fenestration in a 5" X 5" adhesive square 20" from top of drape. Sterile.

Product No. 6058 (not pictured)  
40" X 60" fenestrated Softesse drape. 1.5" X 2" oval fenestration in a 5" X 5" adhesive square 20" from top of drape. Sterile.

Product No. 6060  
40" X 60" fenestrated Softesse drape. 1.5" X 2" oval fenestration in a 5" X 5" adhesive square 20" from top of drape. 8" X 9" fluid collection pouch below fenestration. Sterile.

Product No. 6140 (not pictured)  
Ophthalmology pouch. 8" X 9" pouch with double sided tape for positioning as required and malleable strip for holding pouch open. Sterile.

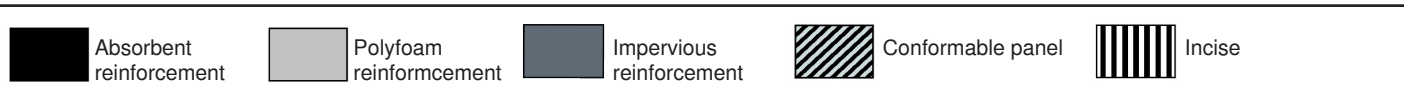
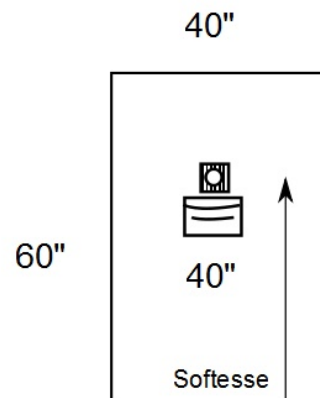
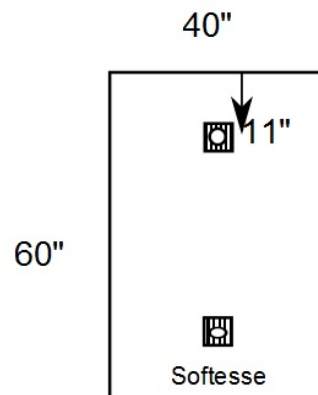

## Small Animal Procedure Kits

Kits listed on these pages are normally stocked and small quantities are available at the time of ordering. Other kits may be special ordered. Automatic shipments of monthly orders are also available. Kits are over-wrapped and sealed in a header pouch for sterilization.

### ***Kits using #3020 – 60" X 80" Impervex drape.***

Product No. 5077

#3020 – 60" X 80" Impervex drape, 1 each.  
#6027 – 24" X 26" Dexter towel drape, 4 each.  
#3205 – 44" X 78" table cover, 1 each.  
Sterile.

Product No. 5081

#3020 – 60" X 80" Impervex drape, 1 each.  
#6027 – 24" X 26" Dexter towel drape, 5 each.  
#3205 – 44" X 78" table cover, 1 each.  
Sterile.

### ***Kits using #3020A – 60" X 80" Impervex drape.***

Product No. 5127

#3020A – 60" X 80" Impervex drape, 1 each.  
#6029 – 24" X 26" Impervex towel drape, 5 each.  
#3205 – 44" X 78" table cover, 1 each.  
Sterile.

Product No. 3022

#3020A – 60" X 80" Impervex drape, 1 each.  
#6081 – 40" X 42" SMS towel drape, 4 each.  
#3205 – 44" X 78" table cover, 1 each.  
Sterile.

### ***Kits using #6010-1 – 44" X 55" Softesse drape.***

Product No. 5080-1

#6010-1 – 44" X 55" Softesse drape, 1 each.  
#6028 – 18" X 26" Impervex towel drape, 4 each.  
Sterile.

### ***Kits using #6011-1 – 55" X 77" Softesse drape.***

Product No. 5016-1

#6011-1 – 55" X 77" Softesse drape.  
#6029 – 24" X 26" Impervex towel drape, 4 each.  
Sterile.

Product No. 5097-1

#6011-1 – 55" X 77" Softesse drape.  
#6022 – 22" X 30" Softesse towel drape, 4 each.  
#3205 – 44" X 78" table cover, 1 each.  
Sterile.

## Other Kits

### Small Animal Arthroscopy Kit

Product No. 5134

Contents:

#6055 – 87" X 124" SMS arthroscopy drape with pouch, 1 each.

#6029 – 24" X 26" Impervex towel drape, 4 each.

#2120 – XL extended procedure gown w/ towel, 1 each.

#3205 – 44" X 78" table cover, 1 each.

Sterile.

### Small Animal Total Hip Kit

Product No. 5111

Contents:

#6012-1 – 77" X 100" Softesse drape, 1 each.

#6025 – 18" X 26" Dexter towel drape, 4 each.

#3110 – 14" X 14" adhesive area incise drape, 1 each.

#3116 – 24" X 18" adhesive area IOBAN incise drape, 1 each.

#3220 – 23" X 53" Mayo stand cover, 1 each.

#3091 – 55" X 70" split sheet, 1 each.

#4007 – 1/4" X 10' suction hose, 1 each.

#4020 – 60 ml bulb syringe, 1 each.

4" X 4.1 yard Conform bandage, 1 each.

#3205 – 44" X 78" table cover, 1 each.

Sterile.

### Small Animal Total Hip Kit

Product No. 5211

Contents:

#3012-1 – 80" X 104" Impervex drape, 1 each.

#6038 – 30" X 30" Impervex towel drape, 4 each.

#3110 – 14" X 14" adhesive area incise drape, 1 each.

#3116 – 24" X 18" adhesive area IOBAN incise drape, 1 each.

#3220 – 23" X 53" Mayo stand cover, 1 each.

#3091 – 55" X 70" split sheet, 1 each.

#4007 – 1/4" X 10' suction hose, 1 each.

#4020 – 60 ml bulb syringe, 1 each.

4" X 4.1 yard Conform bandage, 1 each.

#3205 – 44" X 78" table cover, 1 each.

Sterile.

### Small Animal Orthopedic Kit

Product No. 5098

Contents:

#3005A – 40" X 42" Impervex drape, 4 each.

#3205 – 44" X 78" table cover, 1 each.

Sterile.

### Small Animal Ophthalmology Kit

Product No. 5099

Contents:

#6053 – 40" X 60" Softesse eye drape, 1 each.

#6034 – 24" X 26" Softesse towel drape w/tape, 2 each.

Sterile.

### Small Animal Exploratory Kit

Product No. 5165

#6011 - 55" X 77" Softesse drape, 1 each.

#6022 - 22" X 30" Softeese towel drapes, 4 each.

#2210 - 17" X 27" blue cotton towel, 3 each.

#2225 - 18" X 18" sponge, 5 each.

#2238 - 4" X 4" gauze, 2 packs 10 each.

#4006 - 1/4" X 6' suction hose, 1 each.

#4015 - Poole suction handle, 1 each.

#4016 - Yankauer suction handle, 1 each.

#4020 - 60mL bulb syringe, 1 each.

1000 cc. sponge bowl, 1 each.

#3205 - 44" X 78" table cover, 1 each.

Sterile.

This list is representative of our custom kit packing capabilities. Please call to arrange a quote for a custom kit for your practice



Absorbent reinforcement



Polyfoam reinforcement



Impervious reinforcement



Conformable panel



Incise

# Equine Orthopedic Drapes

## Unilateral Procedure Arthroscopy Drapes

Product No. 3064

140" X 200" Impervex drape. 20" X 30" polyfoam reinforcement on center line and 90" from top of drape. 4" X 12" unfenestrated conformable panel centered on reinforcing. Suction tubing holders. Sterile.

Kits using #3064: 5037 See page 7.

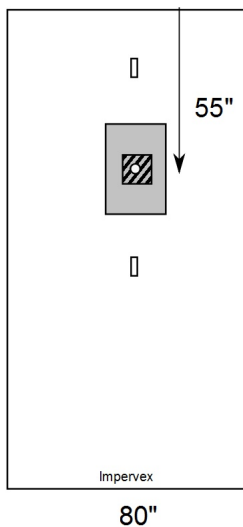
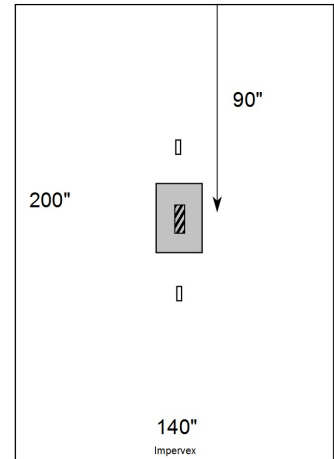

Product No. 3065

80" X 160" fenestrated Impervex drape. 20" X 30" polyfoam reinforcement on center line and 55" from top of drape. 3.5" fenestration in 10" X 10" conformable panel centered in reinforcing. Suction tubing holders. Sterile.

Kits using #3065: 5056, 5035 See page 7.

Product No. 6074 (not pictured)

140" X 160" fenestrated Impervex drape. 20" X 30" polyfoam reinforcement on center line and 55" from top of drape. 3.5" fenestration in 10" X 10" conformable panel centered in reinforcing. Suction tubing holders. Sterile.

Product No. 6047

87" X 126" fenestrated SMS drape. 20" X 38" polyfoam reinforcement on center line 2" X 3" oval fenestration in conformable panel centered in reinforcing. Suction tubing holders. Sterile.

Kits using #6047: 5147 See page 7.

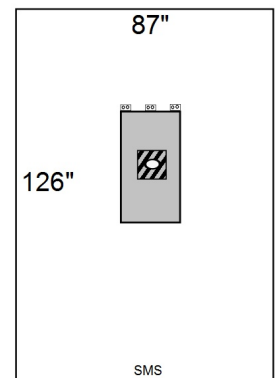

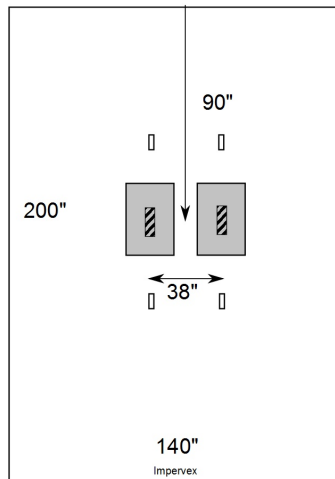
**Bilateral Procedure Arthroscopy Drapes**

Product No. 3069 (pictured at left)

140" X 200" Impervex drape. Two 20" X 30" polyfoam reinforcements. Two 4" X 12" unfenestrated conformable panels 90" from top of drape, 38" apart, and centered on reinforcements. Suction tubing holders. Sterile.

Kits using #3069: 5038 See page 7.

Product No. 3066 (pictured at right)

120" X 160" fenestrated Impervex drape. Two 20" X 30" polyfoam reinforcements. Two 10" X 10" conformable panels with 3.5" fenestrations 55" from top of drape and with 38" separation around mid-line. Suction tubing holders. Sterile.

Drape kits using #3066: 5036 See page 7.

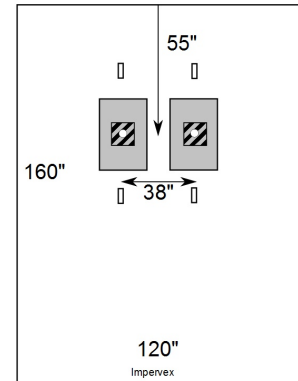
**Equine Arthroscopy/IV Fluid Cuff**

Product No. 3415

Arthroscopy/IV fluid cuff for 5 L fluid bag. Hand inflator with pressure gauge.

Product No. 3416

Arthroscopy/IV fluid cuff for 5 L fluid bag. 5 ft air line with pinch clamp. For use with 3410 inflator pump.

Product No. 3410

Arthroscopy/IV fluid cuff for 3 L fluid bag. Hand inflator with pressure gauge.

Product No. 3431

Arthroscopy/IV fluid cuff for 3 L fluid bag. 5 ft air line with pinch clamp. For use with 3410 inflator pump.

Product No. 3410

Electric compressor for inflation of arthroscopy cuff. Compatible with US and European electrical systems. Allows controlled inflation at the touch of a foot switch.

Product No. 3411

Electric compressor for inflation of dual arthroscopy cuffs. Compatible with US and European electrical systems. Allows controlled inflation at the touch of a foot switch.

**Irrigation Sets**

Product No. 3400

Dual line high volume irrigation set. 8' long. Sterile.

Product No. 3401

Single line high volume irrigation set. 8' long. Sterile.

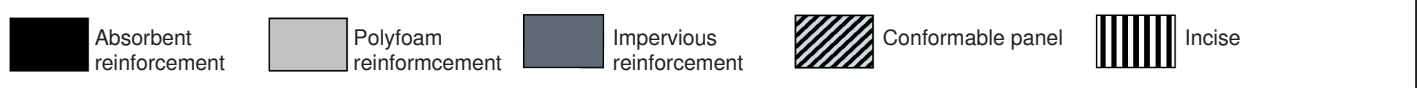

# Large Animal Specialty Sheets

## Equine Cryptorchid/Celiotomy Drapes

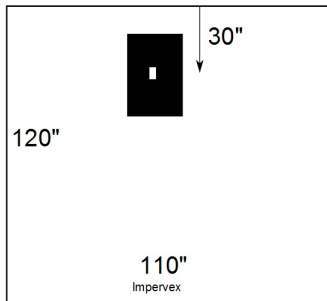

Product No. 3071

Equine cryptorchid/celiotomy drape. 110" X 120" fenestrated Impervex drape. 20" X 30" absorbent reinforcement. 3" X 5" fenestration at drape mid-line and 30" from drape top. Sterile.

Kits using #3071: 5091. See page 7.

Product No. 3072 (not pictured)

Equine cryptorchid/celiotomy drape. 110" X 140" fenestrated Impervex drape. 20" X 30" absorbent reinforcement. 3" X 7" fenestration at drape mid-line and 45" from drape top. Sterile.

## Equine Eye Drapes

Product No. 3055 (not pictured)

Equine eye drape. 40" X 40" Impervex drape with 5" X 5" adhesive center panel and 3" round opening. Sterile.

Product No. 3056

Equine eye drape. 60" X 60" Dexter drape with 5" X 5" adhesive center panel and 3" round opening. Sterile.

Product No. 6056 (not pictured)

Equine eye drape. 44" X 60" Dexter drape with 5" X 5" adhesive center panel and 2" round opening 24" from top of drape. Sterile.

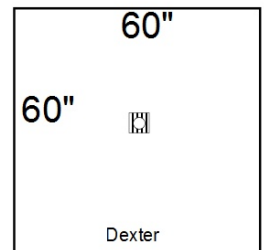

## Equine Throat Drape

Product No. 3060

Equine throat drape. 80" X 160" fenestrated Impervex drape. 20" X 30" absorbent reinforcement. 2" X 5" fenestration on drape mid-line and 54" from drape top. Sterile.

## Equine Leggings

Product No. 5082 (not pictured)

Equine leggings. SMS material. 30" X 41" with 7" cuff. 2 per package. Sterile.

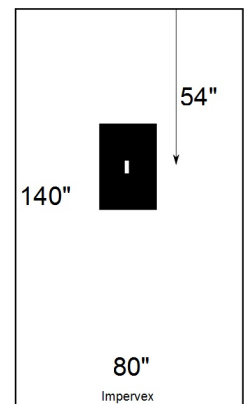

## Large Animal Orthopedic Kits

Kits on this page are normally stocked and small quantities are usually available at the time of ordering. Other kits may be special ordered. Kits are over wrapped and sealed in header pouches. This list is representative of our custom kit packing capabilities. Please call to arrange a quote for a custom kit for your practice.

### Product No. 5035

#3065 – arthroscopy drape, 1 each.  
 #3010 – 40" X 60" Impervex drape, 2 each.  
 #3205 – 44" X 78" table cover, 1 each.  
 Sterile.

### Product No. 5036

#3066 – arthroscopy drape, 1 each.  
 #3010 – 40" X 60" Impervex drape, 4 each.  
 #3205 – 44" X 78" table cover, 1 each.  
 Sterile.

### Product No. 5037

#3064 – arthroscopy drape, 1 each.  
 #3205 – 44" X 78" table cover, 1 each.  
 Sterile.

### Product No. 5038

#3069 – arthroscopy drape, 1 each.  
 #3010 – 40" X 60" Impervex drape, 2 each.  
 #3135 – 4" X 24" tape strip, 2 each.  
 #3205 – 44" X 78" table cover, 1 each.  
 Sterile.

### Product No. 5039

Copelan orthopedic kit  
 #3030 – 140" X 160" Impervex drape, 1 each.  
 #3010 – 40" X 60" Impervex drape, 4 each.  
 #3205 – 44" X 78" table cover, 1 each.  
 Sterile.

### Product No. 5056

#3065 – arthroscopy drape, 1 each.  
 #3205 – 44" X 78" table cover, 1 each.  
 Sterile.

### Product No. 5058

#3066 – arthroscopy drape, 1 each.  
 #3205 – 44" X 78" table cover, 1 each.  
 Sterile.

### Product No. 5070

#3065 – arthroscopy drape, 2 each.  
 #3010 – 40" X 60" Impervex drape, 4 each.  
 #3205 – 44" X 78" table cover, 1 each.  
 Sterile.

### Product No. 5147

#6047 – arthroscopy drape, 1 each.  
 #3205 – 44" X 78" table cover, 1 each.  
 Sterile.



Absorbent  
reinforcement



Polyfoam  
reinforcement



Impervious  
reinforcement



Conformable panel



Incise

# Large Animal Laparotomy Sheets

## Large Animal Laparotomy Sheets with Enterotomy Pouches

All laparotomy sheets and enterotomy pouches are assembled using Impervex material. Fenestrations are centered in drape. Enterotomy pouch is 36" X 40" with plastic interior to minimize sticking of the bowel and allows the surgeon to easily contain the bowel. Top reinforcement is also plastic to minimize sticking of the bowel if the pouch is not used. 4" X 14" fenestration with adhesive. Laparotomy sheets are available with the #3205 44" X 78" table cover. All drapes are available as a component of a custom kit.

Product Number	Overall Size (W X L)	Fenestration Size	Product Number w/ Table Cover
3087	80" X 165"	4" X 14"	5174
3088	120" X 160"	4" X 14"	5191
3089	140" X 210"	4" X 14"	5192

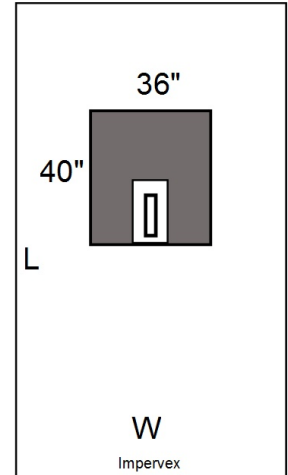

## Large Animal Laparotomy Sheets

All laparotomy sheets are assembled using Impervex material. Fenestrations are centered in drape. #3070 features an absorbent reinforcement while the #3080 and #3085 feature a plastic coated reinforcement to minimize sticking of the bowel. Laparotomy sheets are also available with tape around the fenestration or with an antimicrobial incise panel. Please call for availability of these special order items. Laparotomy sheets are available with the #3205 44" X 78" table cover or as custom kits as well.

Product Number	Overall Size (W X L)	Fenestration Size	Product Number w/ Table Cover
3070 <sup>1</sup>	80" X 110"	3" X 7"	5065
3080*	80" X 160"	4" X 14"	5107
3085	140" X 210"	4" X 14"	3086

<sup>1</sup> RDA Sheet

\* Tullener's Sheet

## Laparotomy Accessories

Product No. 3103

23" X 53" plastic enterotomy tray cover for Shank's table. Sterile.

Product No. 3104

40" X 45" plastic enterotomy tray cover. 5" X 5" adhesive square in center to adhere cover to tray. Sterile.

Product No. 6123 (pictured at right)

Incise drape with tape for adhesion to laparotomy sheet. Overall area 34" X 34". Adhesive area 24" X 34". Sterile.

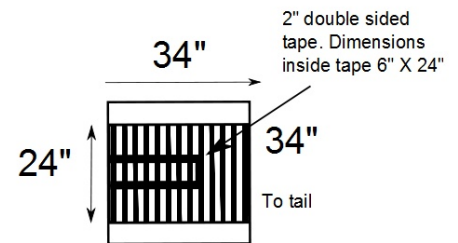

## Viscera Retainers

Product No. 4050

Equine viscera retainer. 9" maximum width and 14" long with pull strap. Polyurethane. ETO sterilize.

Product No. 4051

Equine viscera retainer. 5" maximum width and 9" long with pull strap. Polyurethane. ETO sterilize.

Product No. 4052

Equine viscera retainer. 9.5" maximum width and 14" long with stainless steel cable pull. Silicone rubber. Autoclavable.

## Split Sheets / Incise Drapes / Impervious Stockinette

Product No. 3090

60" X 80" Impervex split sheet. 20" X 30" polyfoam reinforcement. 6" X 24" split. Sterile.

Product No. 3092

60" X 80" Impervex split sheet. 20" X 30" polyfoam reinforcement. 6" X 24" split with 1" tape around split. Sterile.

Product No. 3091

56" X 70" plastic split sheet. 6" X 20" split with 2" tape around split. Sterile.

Product No. 3093

50" X 90" Impervex split sheet. Unreinforced 6" X 36" split. Sterile.

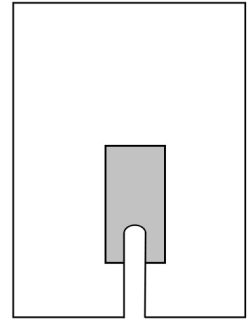

### Incise Drapes

Incise drapes are thin plastic drapes with an adhesive coating on one side. The drape is applied to the surgical site and the incision made through the drape. The drape provides a sterile field and the adhesive prevents skin microbes from entering the incision. Adhesives may be impregnated with antimicrobial solution.

Vet. Surgical Resources offers both 3M incise drapes and MCD incise drapes in several sizes with and without antimicrobial solution. 3M antimicrobial incise drapes are marketed under the loban 2™ brand and MCD antimicrobial incise drapes are marketed under the ACTI-Gard® brand. Plain 3M drapes are marketed under the Steri-Drape™ brand.

		MCD	3M			
Overall area	Adhesive area	ACTI-Gard	Steri-Drape	3M Number	loban	3M Number
34" X 34"	34" X 24"	6106	3105	1051	3106	6651EZ
24" X 14"	14" X 14"	6112	3110	1040	3112	6640EZ
34" X 18"	24" X 18"	6116	3115	1050	3116	6650EZ
34" X 22"	24" X 24"	6122*				
34" X 34"	34" X 24"	6123*				
8" X 8"	4" X 8"	6131				6635

\*6122 and 6123 have tape strips for lap sheet positioning

### Adhesive Spray

Product No. 3130

VI-DRAPE® Adhesive spray in 5 oz. can. Used to improve adherence of incise drapes. Non-sterile.

### Impervious Stockinette

Impervious stretch outer barrier and woven polyester stockinette interior. Sterile. (1/pkg)

Size (in.)	Lay Flat Width (in.)	Unstretched Diameter (in.)	Product Number
3" X 15"	3"	1.9"	2430
4" X 20"	4"	2.5"	2431
7" X 48"	7"	4.5"	2420
9" X 48"	9"	6"	2425
12" X 48"	12"	8"	2429

# Towel Drapes / Table Covers / Sponges

## Towel Drapes

Towel drapes are available non-sterile or packaged four in a Tyvek pouch and sterile.

Size (in.)	Drape material		
	Dexter	Softesse medical fabric	Impervex* medical fabric
18" X 26"	6025	6021	6028
18" X 26" w/ tape	6020		
24" X 26"	6027	6022	6029
24" X 26" w/ tape	6026	6034	6036
30" X 30"		6094	
36" X 36"		6095	

\* Impervex material is not autoclavable.

## Table Covers

Product No. 3205  
44" X 78" blue plastic table cover with 24" wide full length centered SMS lamination. Fan-folded. Sterile. (1/pkg).

Product No. 3206  
44" X 44" blue plastic table cover with 24" wide full length centered SMS lamination. Fan-folded. Sterile. (1/pkg).

Product No. 3207  
50" X 90" blue plastic table cover with 24" wide full length centered SMS lamination. Fan-folded. Sterile. (1/pkg).

## Set-up Cover

Product No. 3210  
54" X 90" clear plastic set-up cover. Fan-folded. Sterile. (1/pkg).

## Mayo Stand Cover

Product No. 3220  
55" X 23" blue plastic Mayo stand cover with 18" X 25" SMS reinforcement and 7" cuff. Sterile. (1/pkg).

## Laparotomy Sponges

Pre-washed 8 ply lap sponges with radio-opaque loops.

Size (in.)	Product Number	
	Non-sterile (5/pkg.)	Sterile (2/pkg.)
4" X 18"	2228	2229
12" X 12"	2234	2232
18" X 18"	2230	2225
36" X 36"	2227 (1/pkg.)	2226 (1/pkg.)

Size	Regular Procedure		Extended Procedure	
	Softesse medical fabric	SMS	Softesse medical fabric	SMS
Small		2104		2102
Large	2105	2105-2, 2106	2115	2103
X-Large	2110	2110-1, 2113	2120	
X-Large, X-Long				2112, 2121
XX-Large	2114	2108	2107	2111

**Regular Procedure Gowns**

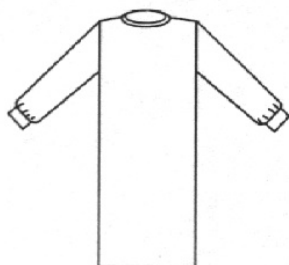

Regular procedure gowns are non-reinforced sterile-back type SMS or Softesse gowns with hook and loop neck closure. Each is individually wrapped and packaged with a hand towel. Sterile. Gowns are also available in custom kits. AAMI certification level information is available at [www.vetsurgicalresources.com](http://www.vetsurgicalresources.com).

**Small**

Product No. 2104

Small regular procedure gown. SMS material with hook and loop neck closure and hand towel.

**Large**

Product No. 2105

Large regular procedure gown. Softesse material with hook and loop neck closure and hand towel.

Product No. 2105-2

Large regular procedure gown. SMS material with hook and loop neck closure, Raglan sleeves, and hand towel.

Product No. 2106

Large regular procedure gown. SMS material with hook and loop neck closure and hand towel.

**X-Large**

Product No. 2110

X-Large regular procedure gown. Softesse material with hook and loop neck closure and hand towel.

Product No. 2110-1

X-Large regular procedure gown. SMS material with hook and loop neck closure, Raglan sleeves, and hand towel.

Product No. 2113

X-Large regular procedure gown. SMS material with hook and loop neck closure and hand towel.

**XX-Large**

Product No. 2114

XX-Large regular procedure gown. Softesse material with hook and loop neck closure and hand towel.

Product No. 2108

XX-Large regular procedure gown. SMS material with hook and loop neck closure, Raglan sleeves, and hand towel.

## O. R. Gowns



### **Extended Procedure Gowns**

Extended procedure gowns are reinforced internally or externally with impervious plastic or fabric and are sterile-back type. They are constructed of SMS or Softesse medical fabric and feature hook and loop neck closure. Sterile. AAMI certification level information is available at [www.vetsurgicalresources.com](http://www.vetsurgicalresources.com).

### **Small**

Product No. 2102

Small extended procedure gown. Internal fabric reinforcement. SMS material with hook and loop closure, Raglan sleeves, and hand towel.

### **Large**

Product No. 2115

Large extended procedure gown. Internal impervious reinforcement. Softesse material with hook and loop neck closure and hand towel.

Product No. 2103

Large extended procedure gown. External impervious reinforcement. SMS material with hook and loop neck closure and hand towel.

### **X-Large**

Product No. 2120

X-large extended procedure gown. Internal impervious reinforcement. Softesse material with hook and loop neck closure and hand towel.

### **X-Large, X-Long**

Product No. 2121

X-Large, X-Long extended procedure gown. Internal impervious reinforcement. SMS material with hook and loop closure and hand towel.

Product No. 2112

X-Large, X-Long extended procedure gown. Full length external impervious reinforcement. SMS material with hook and loop closure and hand towel.

### **XX-Large**

Product No. 2107

XX-large extended procedure gown. Internal impervious reinforcement. Softesse material with hook and loop neck closure and hand towel.

Product No. 2111

XX-Large extended procedure gown. Internal fabric reinforcement. SMS material with hook and loop neck closure and hand towel.

### **Colic Gowns**

Vet Surgical Resources' gowns offer breathable comfort and impervious protection to the wearer. The state of the art fabric reacts with body heat to allow moisture to pass through it, keeping the user cool and dry during long, wet surgeries. The outer impervious layer provides a viral barrier as well as traditional barrier properties. A soft interior layer ensures comfort to the user. This fabric is designed to meet or exceed AAMI Level IV protection. Sterile.

### **Large, X-Long**

Product No. 2101

Large, X-Long, impervious, breathable material colic gown with hand towel.

### **X-Large, X-Long**

Product No. 2100

X-Large, X-Long, impervious, breathable material colic gown with hand towel.

**Sleeves**

Product No. 2125

29" (74 cm) lightweight plastic sleeve with elastic top. Locks to all fingers. Includes tape to seal sleeve to surgeon's glove. Sterile. (1 pair/pkg).

Product No. 2126

39" (99 cm) extra sensitive sleeve with smooth seams. Useful for rectal palpations. Sterile. (1 sleeve/pkg).

**Surgeon's Caps**

Product No. 2130

Blue surgeon's cap with ties. Non-sterile. (100/bx).



**Surgeon's Mask**

Product No. 2135

Fog free surgeon's mask with ties. Latex free with polypropylene outer liner and cellulose inner liner. Non-sterile. (50/bx).

**Surgeon's Beard Cover**

Product No. 2140

White beard cover with elastic head band. Non-sterile. (100/bx).

**Surgeon's Hood**

Product No. 2145

Blue surgeon's hood/beard cover with ties. SMS material. Non-sterile. (100/bx).

**Bouffant Caps**

Product No. 2150

21" (53 cm) blue bouffant caps. Spunbonded material. Non-sterile. (100/bx).

**Shoe Covers**

Product No. 2155

Universal size blue shoe cover. Non-skid sole. Non-sterile. (50 pair/bx).

Product No. 2160

High-top shoe cover. White Tyvek with non-skid sole. Non-sterile. (25 pair/bx).



## Equipment Covers

### ***Drill Shroud***

Product No. 2700

Disposable Impervex drill shroud for Makita drill. Individually sterilized. Adhesive closure. (5/pkg).

### ***Bone Saw Covers***

Product No. 2705/2706

Telescoping cover for air or electric powered Slocum motor and cord/hose. Eliminates need to ETO sterilize saw motor unit and cord. 90" extended length. Fits Slocum models 716 OSE and 714 OS. Also fits the Stryker reciprocating saw motor. Sterile.

Product No. 2710

Cover for battery powered Slocum saw. 30" overall length. Fits Slocum model 715 OSB. Sterile.

### ***X-ray Cassette Covers***

Product No. 3805

Cassette cover for 8" X 10" or 10" X 12" film. Cover has cuff and adhesive closure. Sterile. (2/pkg).

Product No. 3806

Cassette cover for 14" X 17" film. Cover has cuff and adhesive closure. Sterile. (2/pkg).

Product No. 3807

Cassette cover for 7" X 17" film. Cover has cuff and adhesive closure. Sterile. (2/pkg).

Product No. 3809

Cassette cover for 8" X 10" or 10" X 12" film and cassette with handle. Cover has cuff and adhesive closure. Covers cassette and handle. Sterile. (2/pkg).

### ***Digital X-ray Receptor Covers***

Product No. 3808

Telescoping digital x-ray receptor cover allowing aseptic introduction into OR. Covers cable and receptor. 16" X 72". Fits Elkin models EDR3 and EDR3 Mark II as well as IDEXX EquiView DR. Sterile.

Product No. 3811

Telescoping digital x-ray receptor cover for Sound Technologies aCapella and TruDR Small Animal systems. 26" X 48". Sterile.

Product No. 3812

Telescoping digital x-ray receptor cover allowing aseptic introduction into OR. Covers cable and receptor. 22" X 72" Fits Elkin models EDR 5 and EDR 6, IDEXX DR 1417, and Sound Technologies TruDR Equine. Sterile.

### ***C Arm X-ray Machine Covers***

Product No. 3810

C arm x-ray machine cover for isolating machine in OR. 38" X 63". Sterile.

## Equipment Covers / Suction Components / Miscellaneous O.R. supplies

### **Flouroscope Cover**

Product No. 3850  
Flouroscope cover. 36" X 44" clear anti-static plastic cover with tape. Sterile.

### **Video Camera Cover**

Product No. 3860  
Video camera cover. 5" X 96" telescoping cover for camera and cable. Includes tape strip for closure. Sterile.

### **Suction Hose**

1/4" inch inside diameter flexible PVC tubing with female ends. Sterile. (1/pkg).

Length (ft.)	Product No.
6	4006
8	4008
10	4007
12	4005

### **Suction Adapters**

Product No. 4010  
Adapts 1/4" female suction line to male luer needle. Individually sterilized. (10/pkg).

### **Suction Handles**

Product No. 4015  
Poole suction handle with dual action tip. Sterile.

Product No. 4016  
Yankauer non-vented suction handle with bulb tip. Sterile.

### **Syringes**

Product No. 4020  
60 mL Bulb syringe. Sterile.

Product No. 4021  
2 oz. Ear syringe. Sterile.

### **Fiber Optic Light Cover**

Product No. 3865  
Fiber optic light cover. 5" X 36" long to cover light head and bundle. Includes tape strip for closure. Sterile.

### **Ultrasound Cover**

Product No. 3870  
Ultrasound probe cover. 4" X 96" telescoping to cover probe and cable. Sterile.

Product No. 3871  
Ultrasound gel. Individually sterilized. 20 gram foil packet. Parker Laboratories #01-01

### **Adhesive Strips**

Product No. 3135  
Adhesive strips. 4" X 24". Blue poly with release liner. Sterile. (2/pkg).

### **Instrument Pad and Wire/Hose Holder**

Product No. 4042  
10" X 20" foam pad and hook and loop (Velcro) wire and tubing holder. May be applied to drape in any position with included tape. Sterile.

### **Instrument Sorters**

Product No. 4040  
6 pocket polyfoam instrument sorters. 2" X 1.5" pockets with flap. Pockets are perforated and may be separated. Autoclavable. (2/pkg.)

Product No. 4041  
1 pocket polyfoam instrument sorters. 6.75" X 4" pocket. Autoclavable.

### **Sponge Bowls**

Product No. 4070  
1000 cc sponge bowl. ETO sterilize only. Non-sterile.

Product No. 4071  
500 cc sponge bowl. ETO sterilize only. Non-sterile.

Product No. 4072  
1200 cc pitcher. ETO sterilize only. Non-sterile.

### **Gauze Squares**

3" X 3" 12 ply gauze squares in packs of 10.  
Product No. 2235NS (10/pkg). Non-sterile.

4" X 4" 16 ply gauze squares in packs of 10. Radio opaque.  
Product No. 2238NS (10/pkg). Non-sterile.  
Product No. 2238 (10/pkg). Sterile.

## Miscellaneous O. R. Supplies

### *Tubular Stockinette*

25 yard roll. Polyester material. Non-sterile.  
 Product No. 2405 3" X 25yd.  
 Product No. 2410 4" X 25yd.  
 Product No. 2415 6" X 25yd.

### *OR Towels*

17" X 27" pre-washed blue cotton OR towel.  
 Product No. 2205 (2/pkg). Sterile.  
 Product No. 2210 (5/pkg). Non-sterile.

### *Sterilization Pouches*

Paper self-sealing pouches with chevron opening and steam and ethylene oxide sterilization indicators. Pouch is constructed of heavy medical grade paper backing and blue tinted plastic front. Suitable for EO sterilization and autoclaving.

Size (in)	Size (cm)	Pouches/pkg.	Product No.
2.25" X 5.25"	6 X 13	200	3300
3.5" X 10"	9 X 25	200	3305
3.5" X 6.5"	9 X 17	200	3315
5.25" X 11"	13 X 28	200	3320
7.5" X 13"	19 X 33	100	3325
12" X 15"	30 X 38	100	3330

### *Esmark Bandages*

Available wrapped and sterile or non-sterile. 0.15" thick latex. (1/pkg).

Size	Sterile Product No.	Non-sterile Product No.
3" X 6 ft.	4032	4032NS
3" X 9 ft.	4030	4030NS
4" X 12 ft.	4031	4031NS
6" X 12 ft.	4033	4033NS

### *Sterilization Wrap*

Sterilization wrap is used in the sterilization of instruments, kits, and devices for patient care. Dextex™ wrap is compatible with steam, ethylene oxide, and gamma irradiation sterilization processes. Wrap is designed for single use and should be inspected prior to use. Wrap is available in Dextex. 45" wrap is available in SMS.

Size	Sheets/pkg.	Product No.
20" X 20"	50	3176
24" X 24"	50	3180
30" X 30"	25	3184
36" X 36"	25	3185
45" X 45"	25	3190



**Vet. Surgical Resources, Inc.**

PO Box 368

Darlington, MD 21034

Phone, Continental USA & Canada: **1-800-354-8501**

Fax or Phone: **1-410-457-5616**

Web Site: ***www.vetsurgicalresources.com***

Email: ***wecare@vetsurgicalresources.com***